

- A) Ventilation d'air chaud
- B) Entrée d'air
- C) Sortie d'air
- D) Câble d'alimentation
- E) Contrôleur

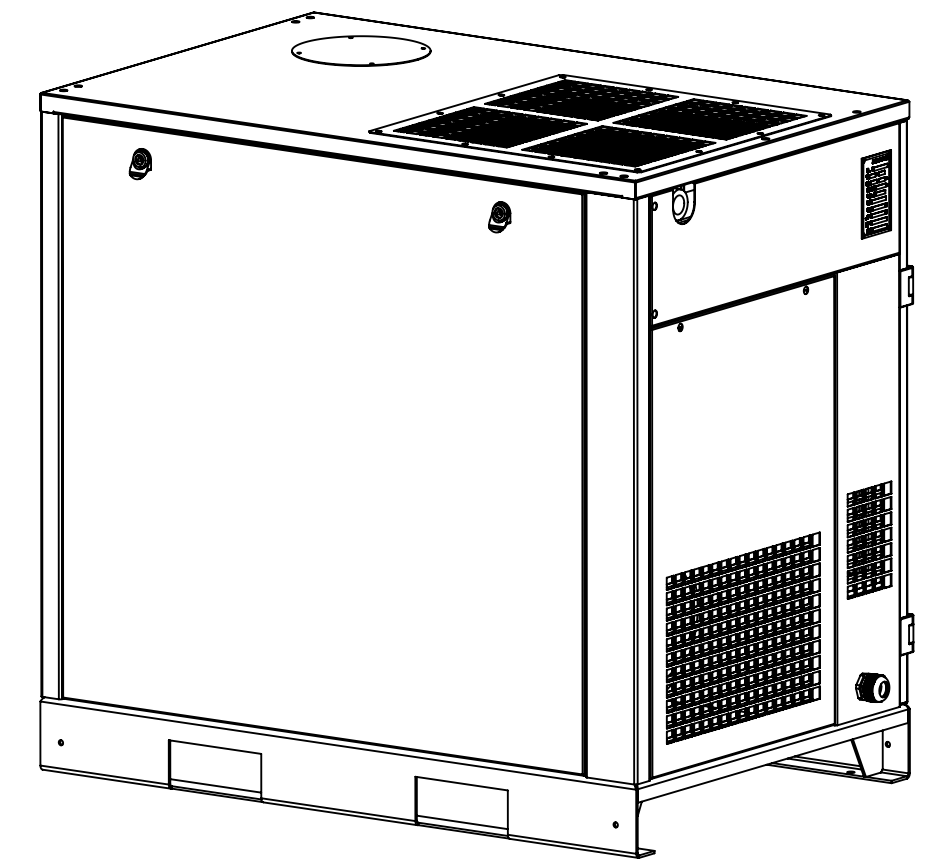

					Constructeur					Numéro	
										EM36150310001	
										Matériel	
										VPM 110	
										Éole MISTRAL 2.0	
Mark	QTY	File No.	sign	Date	Trial	Product	QTY	Weight	Scale		
Designer	LXD	Versions	1.0								
Controller		Judgement									
Check		Date	2022.07.02								

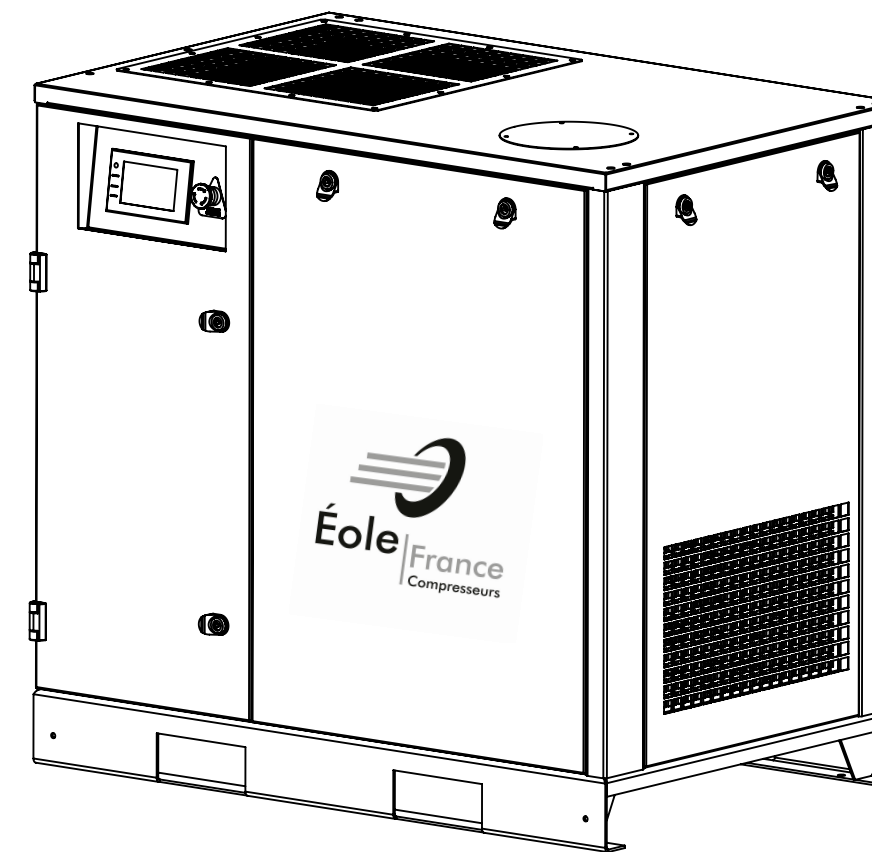